

User' s Manual

Bluetooth Digital Pitch Caliper

Type : SSC-650P/650E/650C

Features

- Measuring easily Pitch hole to hole or Pitch edge to hole
- Resolution : 0.01mm
- Wireless communication : Bluetooth



Flat plate Cone

Q-148-1-E ver1.1

Description



 **SSC-650P**

Flat plane cone

■ Measuring Pitch hole to hole or Pitch edge to hole

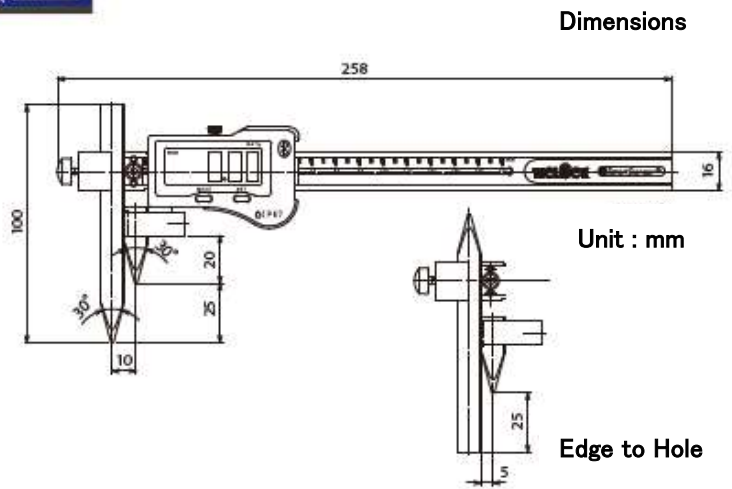

 **SSC-650E**

Cone
Flat plane

■ Measuring Pitch edge to hole

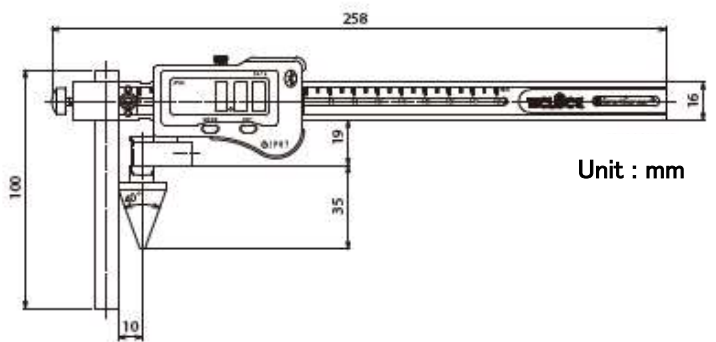

 **SSC-650C**

Cone

■ Measuring Pitch hole to hole

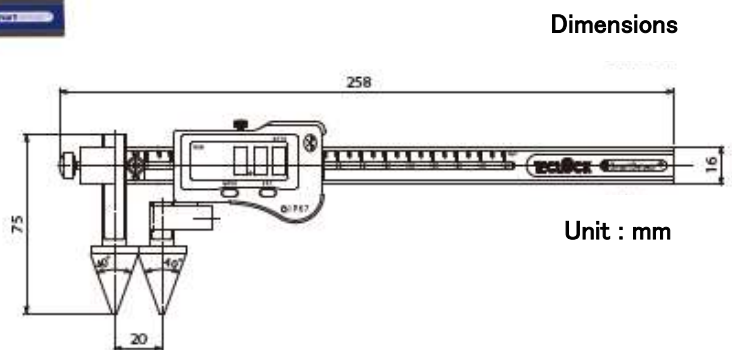

Description

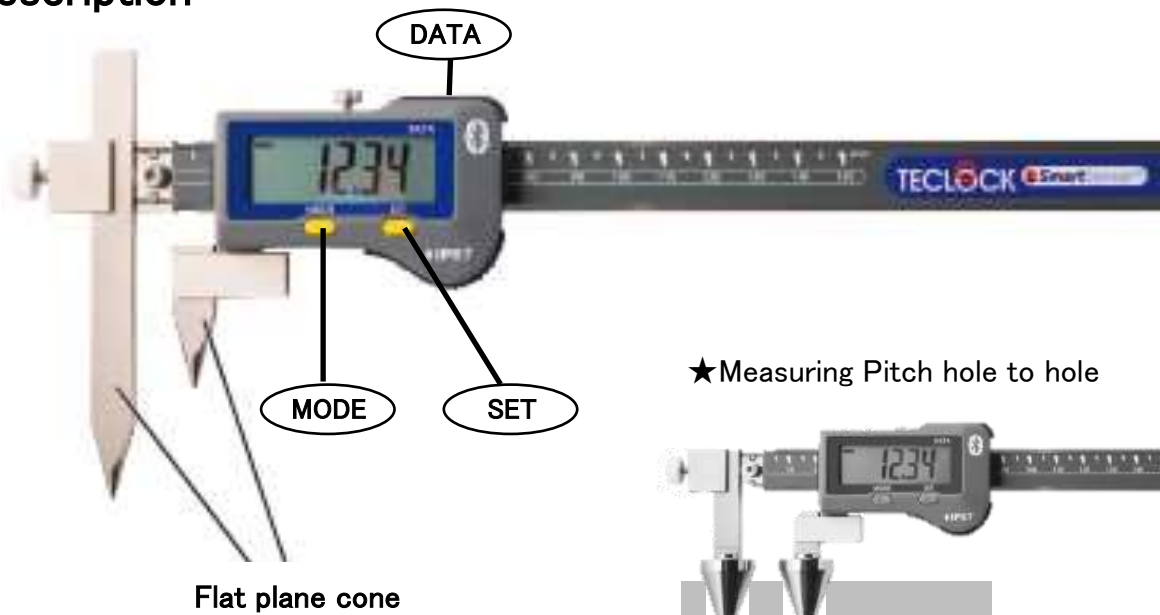

★Operation

① Button **MODE**

There are two functions, Basic one and Advanced one.

② Button **DATA**

In the case of measuring, Data transmission. In the case of setting, Data enter.

③ Button **SET**

Preset by long press. In the case of setting, Data change.

④ Serial communication (Bluetooth/RS232/USB)

It is able to transmit the measuring data and set the mode data by serial communication.

Transmission specification are 4800bps, 7 bits, even parity and 2 stop bits.

[1] Basic functions : MODE button ⇒ Short press (< 1 sec)

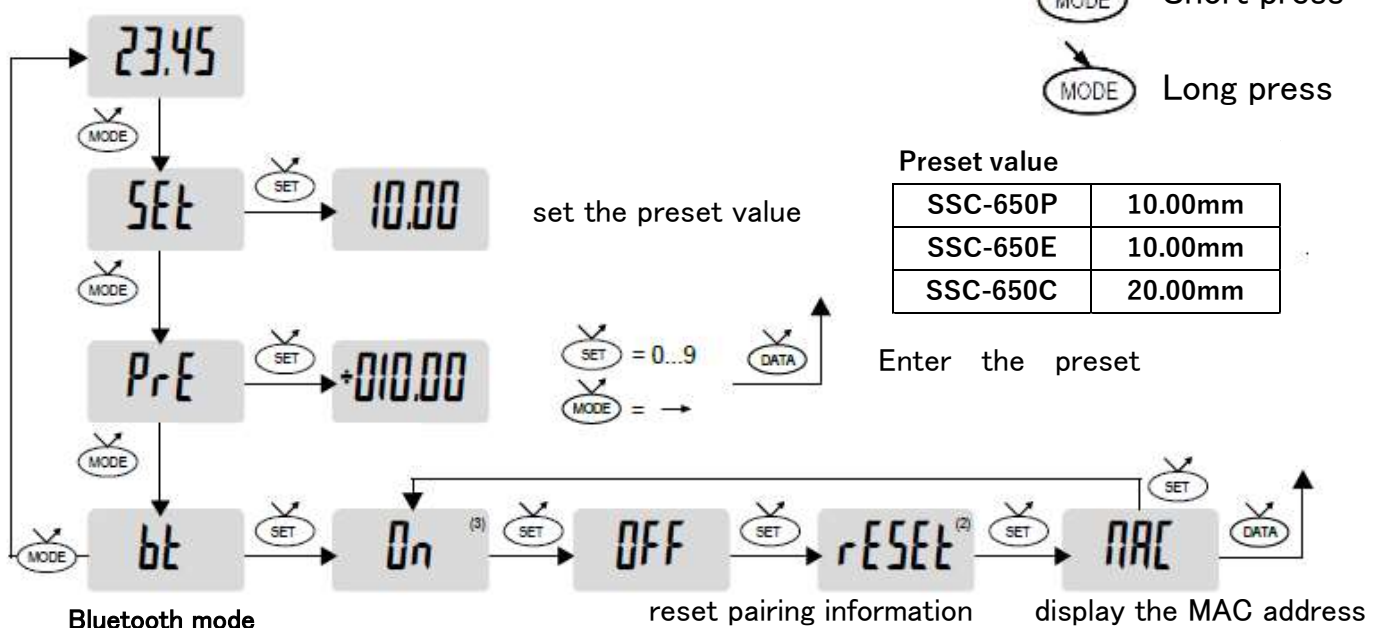
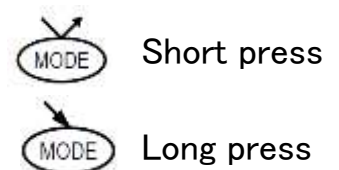

[2] Advanced functions : MODE button⇒Long press(> 1 sec)

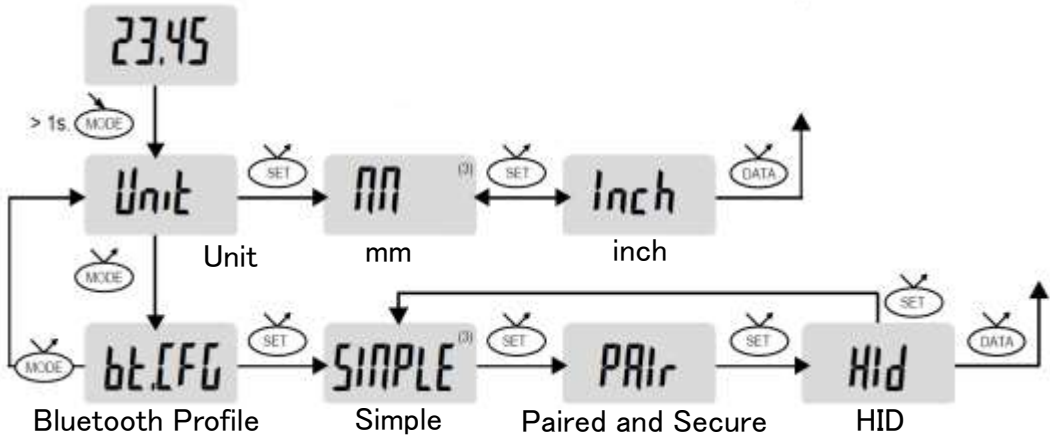

- (2) not available with Simple profile
- (3) Active configuration displays first

[3] Switching off

SET button⇒Long Press(> 2 sec)

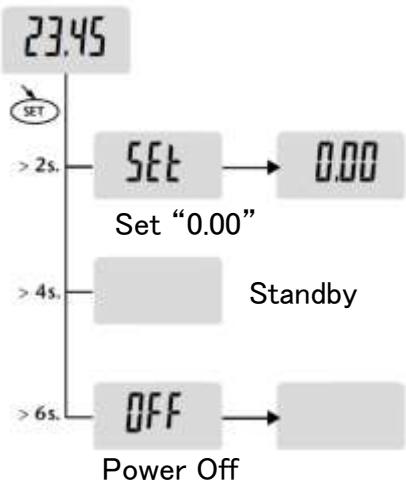

[4] Favorite setting : DATA button⇒Long Press(> 1 sec)

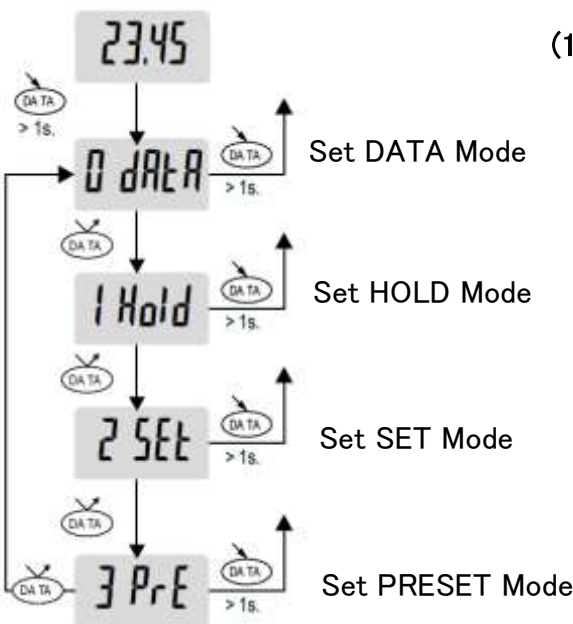

(1)Activation/Deactivation

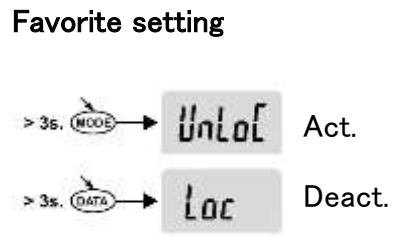

[5] Replacing the battery



[6] Operation via Bluetooth









6.1. HID mode (External Key board mode)

- ① Set HID mode by Advanced function.
- ② Set BT On mode by Advanced function.
- ③ Reset Bluetooth mode by Basic function.
- ④ Pairing connection the instrument to the PC.
(Instrument name : S_Cal EVO HID)
- ⑤ Send the measured data by the DATA button.

6.2. Pair mode

- ① Set Pair mode by Advanced function.
- ② Set BT On mode by Advanced function.
- ③ Reset Bluetooth mode by Basic function.
- ④ Pairing connection the instrument to the PC.
(Instrument name : SY295)
- ⑤ Send the measured data by the DATA button.

6.3. Bluetooth configuration

Display status	Operating mode
 off	Bluetooth disconnected
 blinking	Bluetooth advertising
 on	Bluetooth connected
	reset : clear pairing information
	MAC : display the MAC address
	Simple : profile without pairing
	Pair : paired and secured profile
	HID : virtual keyboard

6.4. Bluetooth Connection :

- 1° Activate Bluetooth compatible software and hardware (Master: PC, Display Unit).
- 2° Start the instrument. By default the Bluetooth® module is active and the instrument is available for connection (advertising mode).
- 3° If no connection is established during the advertisement period reactivate the Bluetooth® module using the **bt / On** menu.
- 4° Instrument is ready to communicate (connected mode.)

6.5. Only with paired profile:

Pairing with master is automatically done at first connection.

To connect the instrument to a new master (new pairing), pairing information on the instrument must be cleared using the **bt / rESET** menu.

6.6. Bluetooth® Specifications:

Items	Specification
Frequency band	2.4GHz
Modulation	GFSK
Max output power	Class3(1mW)
Range	≤ 15m (open space), 1-5m (industrial environment)
Version	Bluetooth4.*

[7]仕様

Items	SSC-650P	SSC-650E	SSC-650C
Resolution(mm)	0.01		
Measuring Range(mm)	5~150/10~150	10~150	20~150
Indication Error(mm)	±0.03	±0.03	±0.03
Repeatabirity(mm)	±0.01		
Max slider speed(m/sec)	2.5		
Display refresh rate(times/sec)	min 10		
Data output	Bluetooth		
Mean power consumption(μ A)	45		
Battery life	about 6 months(general using)		
Woking temperature($^{\circ}$ C)	5~40		
Storage tempaerature($^{\circ}$ C)	-10~60		
Weight(g)	235	265	300
Battery	CR2032		
Span(mm)	258		
Fixed jaw	Flat plane Cone	Flat plane	Cone
Slider jaw	Flat plane Cone	Cone	Cone

[8]Maintenance

Carefully dry all mechanical parts of the instrument after contact with liquids to ensure proper operation and avoid corrosion.





Don't use aggressive products (alcohol, trichloroethylene or others) to clean plastic parts.

Don't expose the instrument to direct sunlight, heat or humidity.

[9]Description of Bluetooth® module:

This module is based on Nordic Semiconductor nRF8001 μ Blue Bluetooth Low Energy Platform. The nRF8001 is a single chip transceiver with an embedded baseband protocol engine, suitable for ultra-low power wireless applications conforming to the Bluetooth Low Energy Specification contained within v4.0 of the overall Bluetooth specification. The nRF8001, used in the current revision of ISP091201, is a product using a ROM for the baseband protocol engine.

[10]Certification

contains bluetooth module	ISP091201D
Region	Certification
USA	FCC ID : 2AAQS-ISP091201
Canada	IC : 11306A-ISP091201
Brazil	Anatel : 0516-14-4534
Korea South	 MSIP-CRM-iNs-ISP091201
Mexico	IFT : RCPSYIS14-0655
Japan	  001-A06167
Taiwan	 CCAH18LP2040T6
EU	
India	WPC : ETA-1003/2-17-/RLO(WR)

CERTIFICATE OF CALIBRATION

We hereby certify that this product has been calibrated and found to be in accordance with the applicable NATIONAL STANDARDS and TECLOCK STANDARDS, Equipment used in this calibration has traceable accuracy to the NATIONAL LENGTH and FORCE STANDARD.



Notice for use

Be sure to conduct a routine check for this product according to the purpose of use before use. This product is precision instrument, periodically considering frequency of use, environmental conditions and method of use.

It is not guaranteed for the performance of this product, which has been repaired or disassembled by other than TECLOCK.

For appearance and other design improvement, this products subject to change without advance notice.

TECLOCK Corporation
TECLOCK SmartSolutions Corporation
<http://www.teclock.co.jp>

HEAD OFFICE

2-10-3 MARUTA-CHO, OKAYA-SHI, NAGANO-KEN 394-0042
PHONE:81-266-22-4912, FACSIMILE:81-266-22-4914
E-mail:teclock@teclock.co.jp